

Inox Forniture

Codice P1105__-A4
PENSILINA INOX AISI 316 A 2 TIRANTI

- Materiale Acciaio INOX AISI 316 SATINATO
- Lunghezza massima 2350 mm.
- Per vetro da 13,52 mm a 25,52 mm **NON COMPRESO**

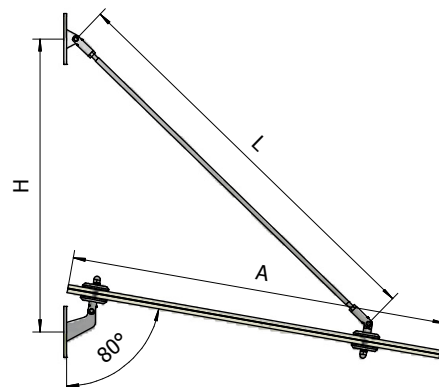
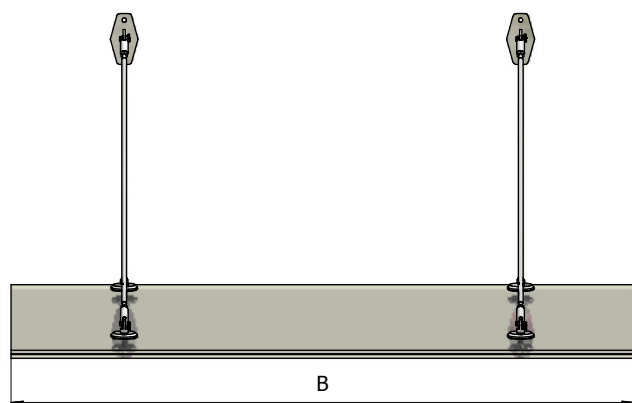
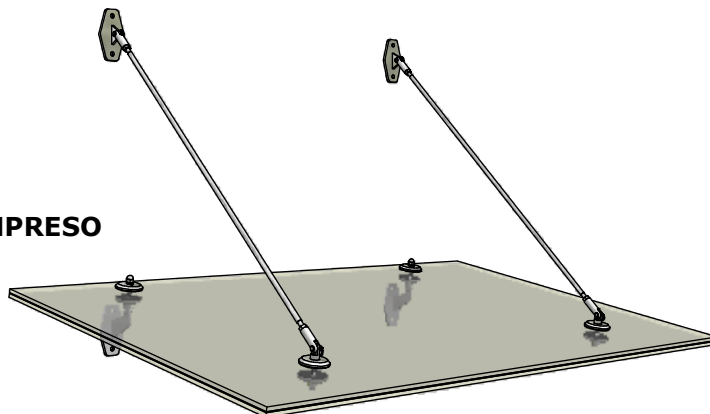

Codice	A	B MAX	L	H	carico variabile (kN/m ²)	spessore vetro	spessore vetro	spessore vetro	spessore vetro
						6+1,52+6	8+1,52+8	10+1,52+10	12+1,52+12
P110500-A4	1000	1750	1080	788		3,36	5,16	6,99	9,51
P110501-A4	1200	1750	1356	949		2,58	3,75	5,31	7,26
P110502-A4	1400	2350	1631	1110		X	X	2,85	4,1
P110503-A4	1600	2350	1907	1271		X	X	2,32	3,26

Fissaggio superiore

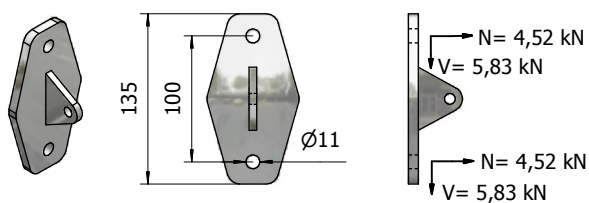

Fissaggio inferiore

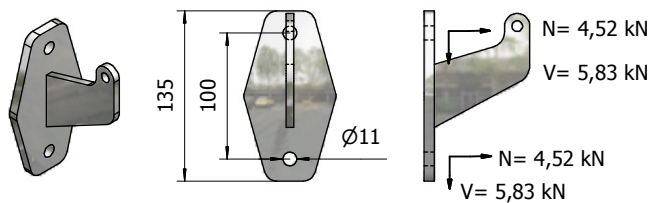

Supporto vetro per il tirante

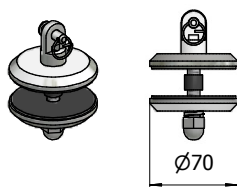

Supporto vetro per fissaggio inferiore

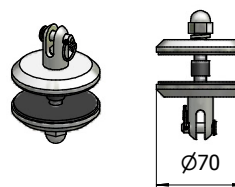

Codice P1105__-A4
PENSILINA INOX AISI 316 A 2 TIRANTI

- Materiale Acciaio INOX AISI 316 SATINATO
- Lunghezza massima 2350 mm.
- Per vetro da 13,52 mm a 25,52 mm **NON COMPRESO**

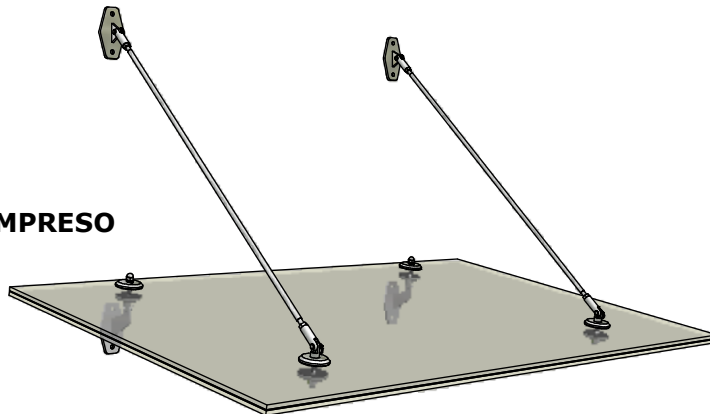

SCHEMA DI FORATURA VETRO (Vetro non compreso)

per ottenere la certificazione è obbligatorio adoperare vetro indurito stratificato

